

VIS TOL-ACIER INOX 6.3X25(100)

Quincaillerie > Quincaillerie Fixation > Visserie > Vis couverture > Vis tôle-acier > VIS TOL-ACIER INOX 6.3X25(100)

<https://ravatepro.fr/vis-tol-acier-inox-6-3x25-100.html>

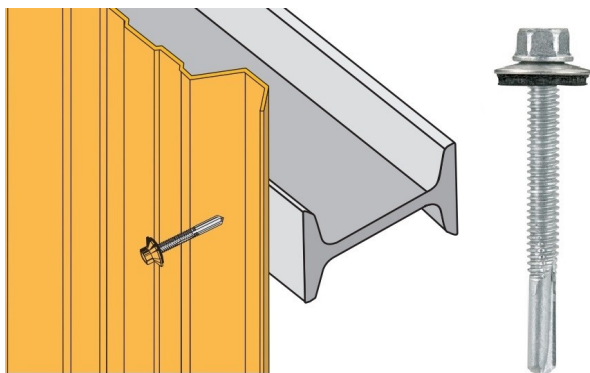

Description courte

Marque : LAURENT

Fabricant :

Référence :75700979

Vis autoperceuse+ rondelle vulcamontée (couverture)

Description

Photos non contractuelles

Informations complémentaires

Quantité d'unité	1
Type d'unité	BOITE
Référence Fournisseur	R246062516
Marque	LAURENT

Images du produit

